

佛司特[®]

採光通風天窗安裝流程
採光罩安裝

安裝前說明I:產品內容-天窗

箱子內容:附有產品組裝圖

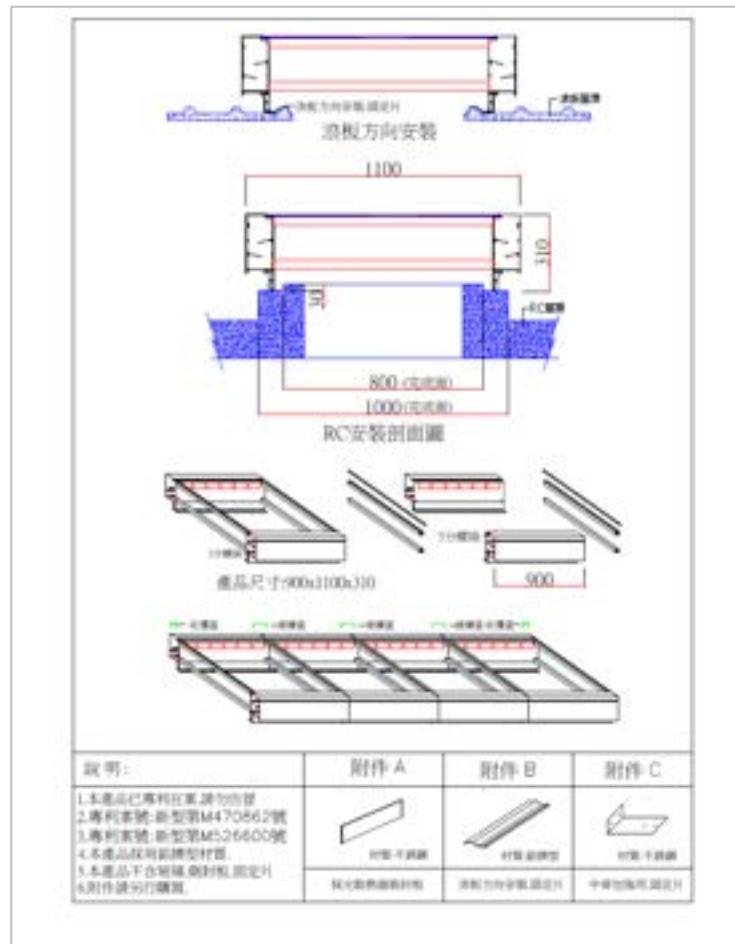

安裝前說明I:產品內容-天窗

內含:

- ① 天窗管體*2
- ② 卡榫連接桿*2支
- ③ 連接桿*2支
- ④ 連續蓋*1支
- ⑤ 收邊蓋*2支
- ⑥ 六角螺絲*8顆

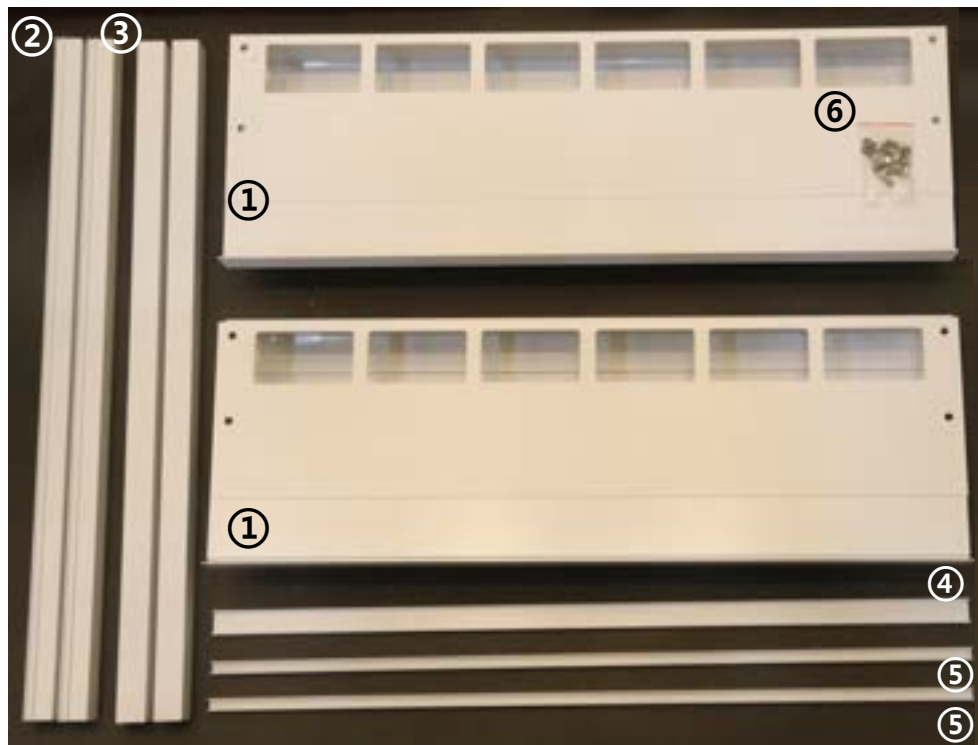

組裝採光通風天窗

取出天窗管體，放入不鏽鋼紗網。

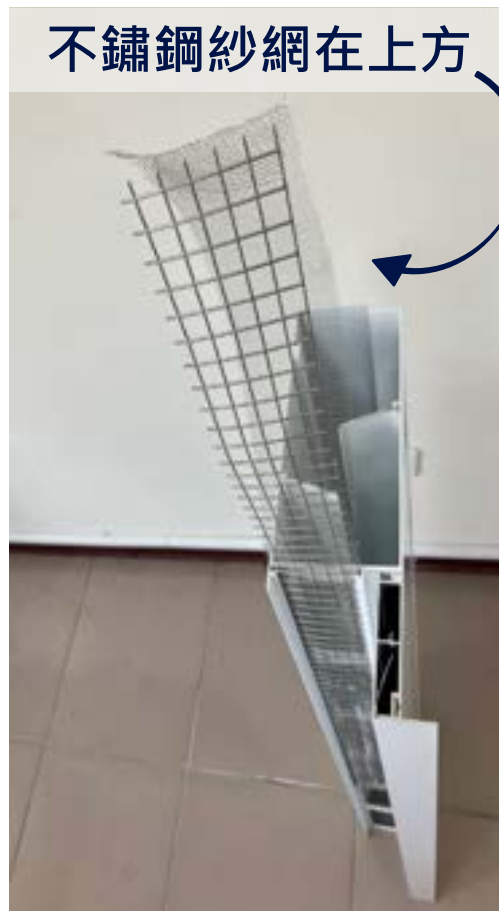

組裝採光通風天窗

兩側分別裝上連接桿，有凸槽面為卡榫上連接桿。

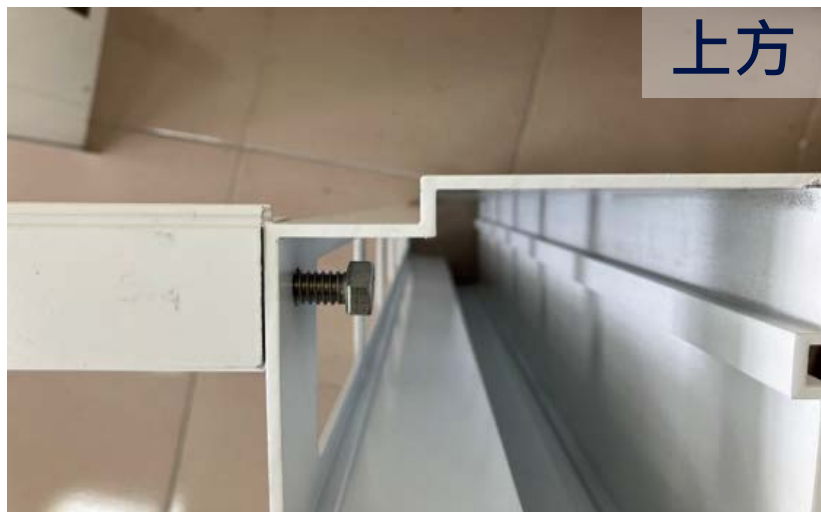

組裝採光通風天窗

兩側放上收邊蓋。連續蓋(寬版邊蓋)為兩樘以上續接用。



組裝採光通風天窗-完成

主體組裝完成

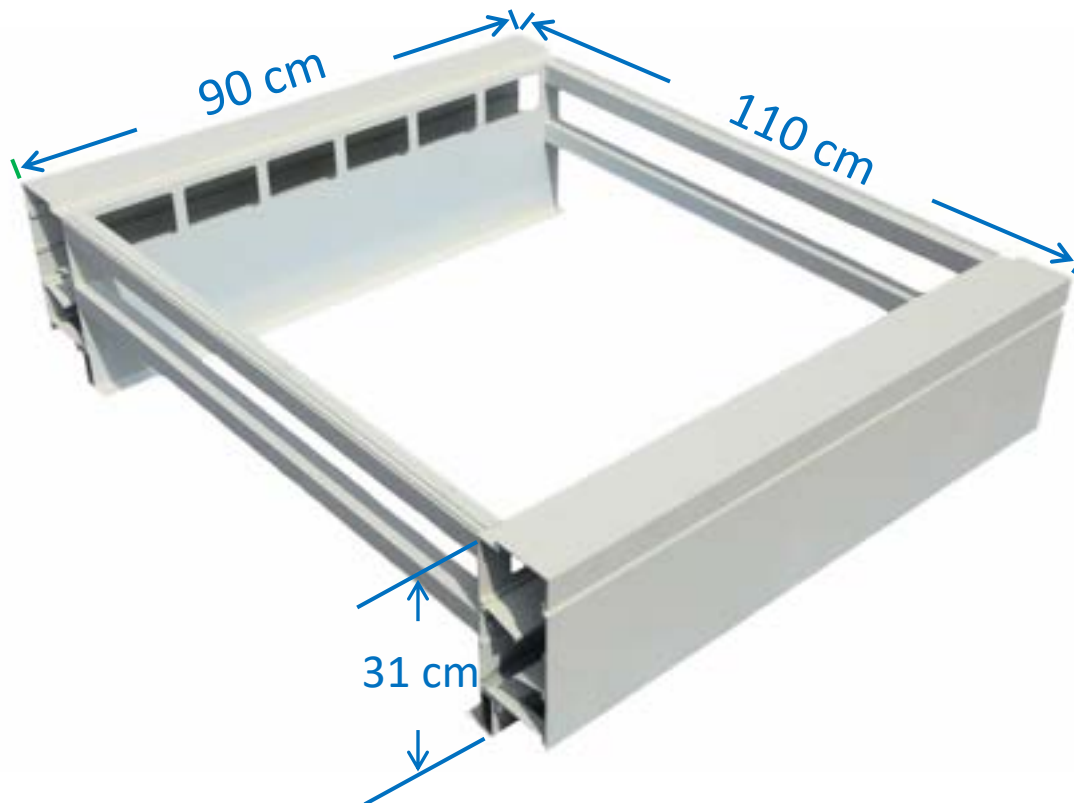

安裝流程

將採光通風天窗置於採光罩上做固定，前後鎖上側封板。
(鎖前建議在側封板三邊打矽利康)



安裝流程:矽利康填縫

蓋上玻璃，天窗與骨架、玻璃接觸面施打矽利康。
(建議使用道康寧等級以上矽利康)

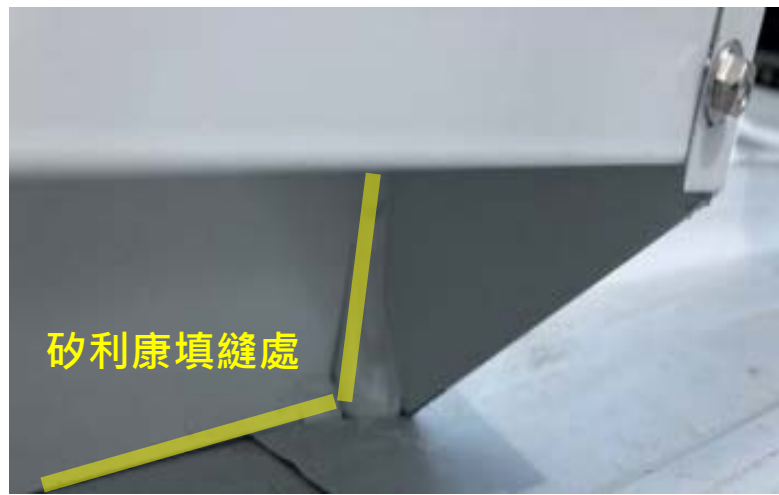
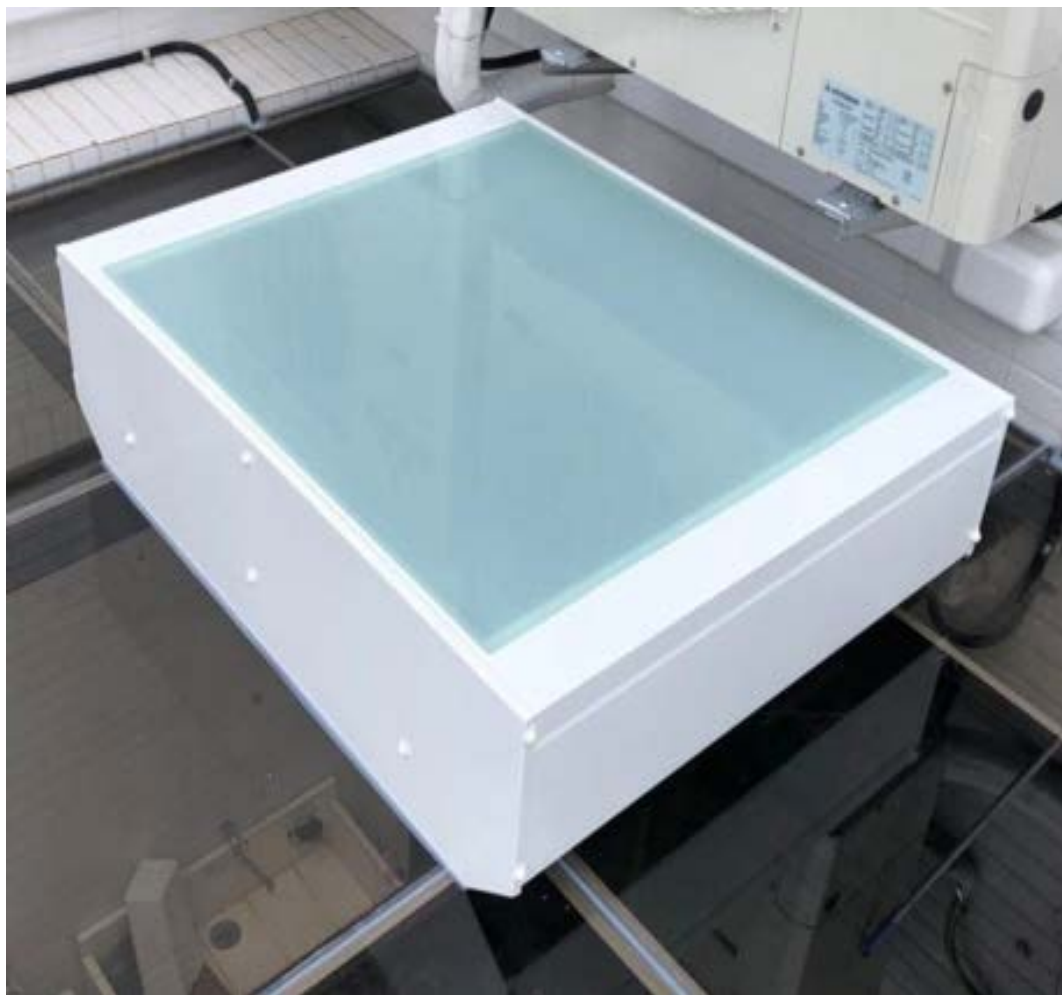

完成照

