

佛司特[®]

採光通風天窗安裝流程

浪板中脊安裝

安裝前說明I:產品內容-天窗

箱子內容:附有產品組裝圖

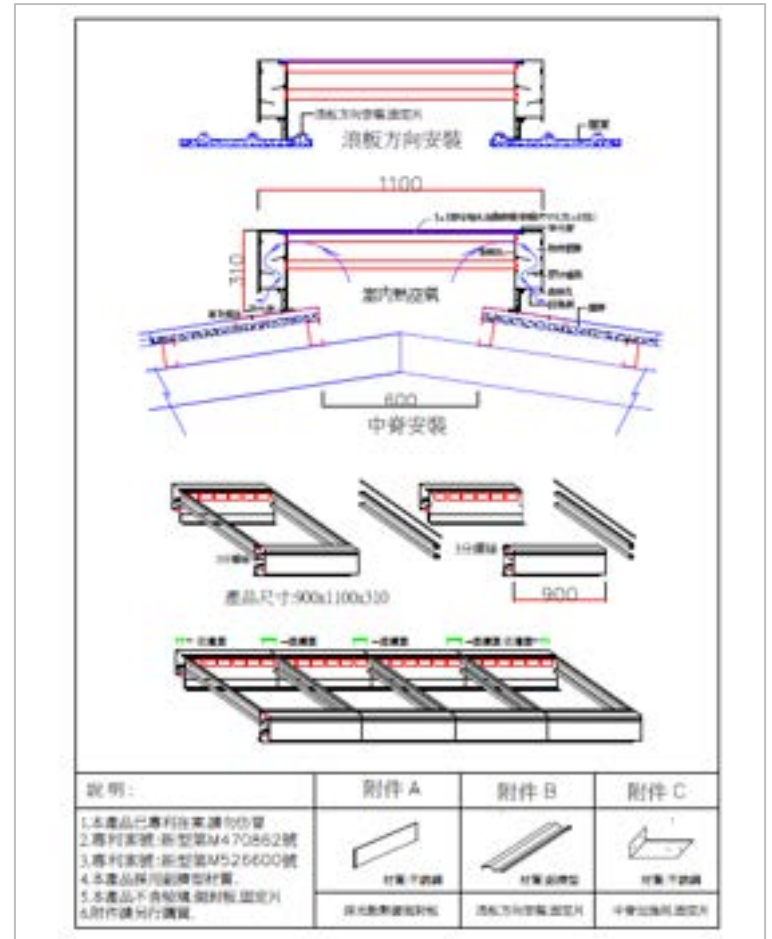

安裝前說明I:產品內容-天窗

內含:

- ① 天窗管體*2
- ② 卡榫連接桿*2支
- ③ 連接桿*2支
- ④ 連續蓋*1支
- ⑤ 收邊蓋*2支
- ⑥ 六角螺絲*8顆
- ⑦ 浪板方向固定板*2支

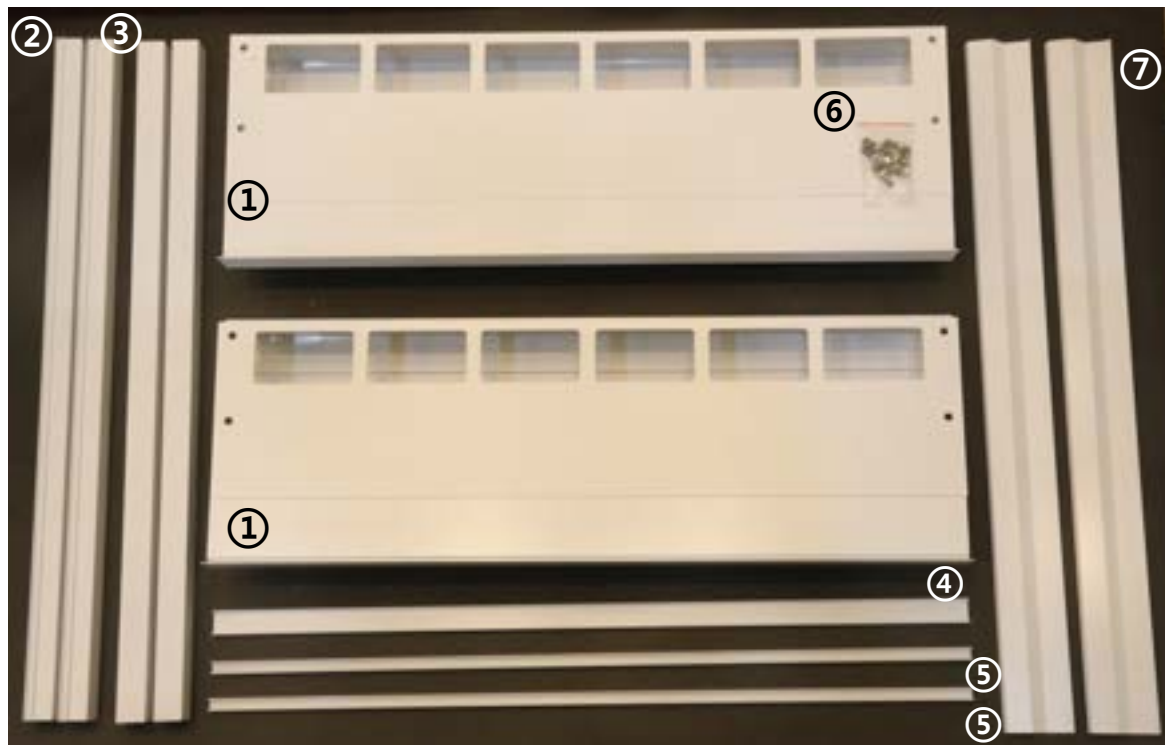

安裝前說明II:水切(自行準備)

水切依現場浪板實際尺寸訂製。



組裝採光通風天窗

取出天窗管體，放入不鏽鋼紗網。

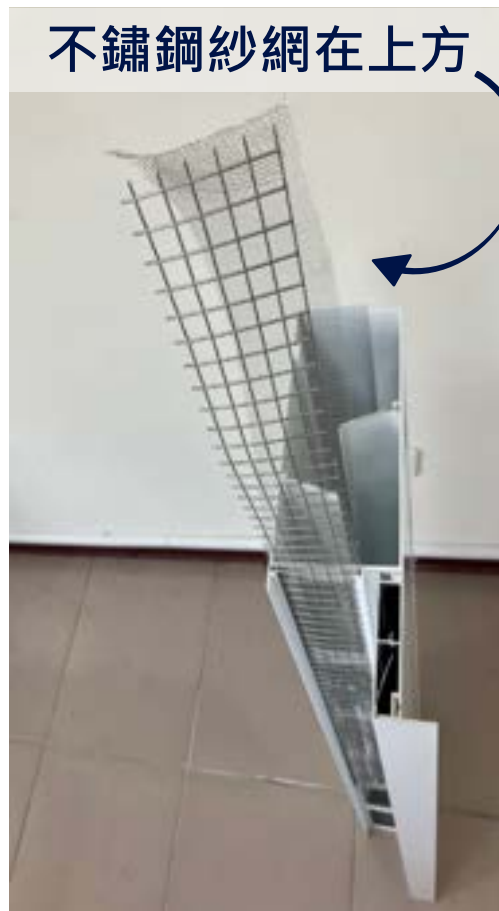

組裝採光通風天窗

兩側分別裝上連接桿，有凸槽面為卡榫上連接桿。

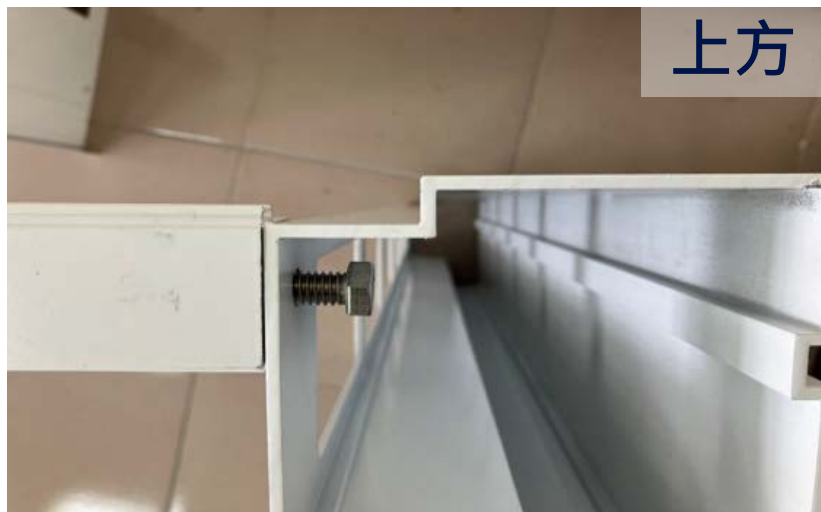

組裝採光通風天窗

兩側放上收邊蓋。連續蓋(寬版邊蓋)為兩樘以上續接用。



組裝採光通風天窗-完成

主體組裝完成

佛司特®

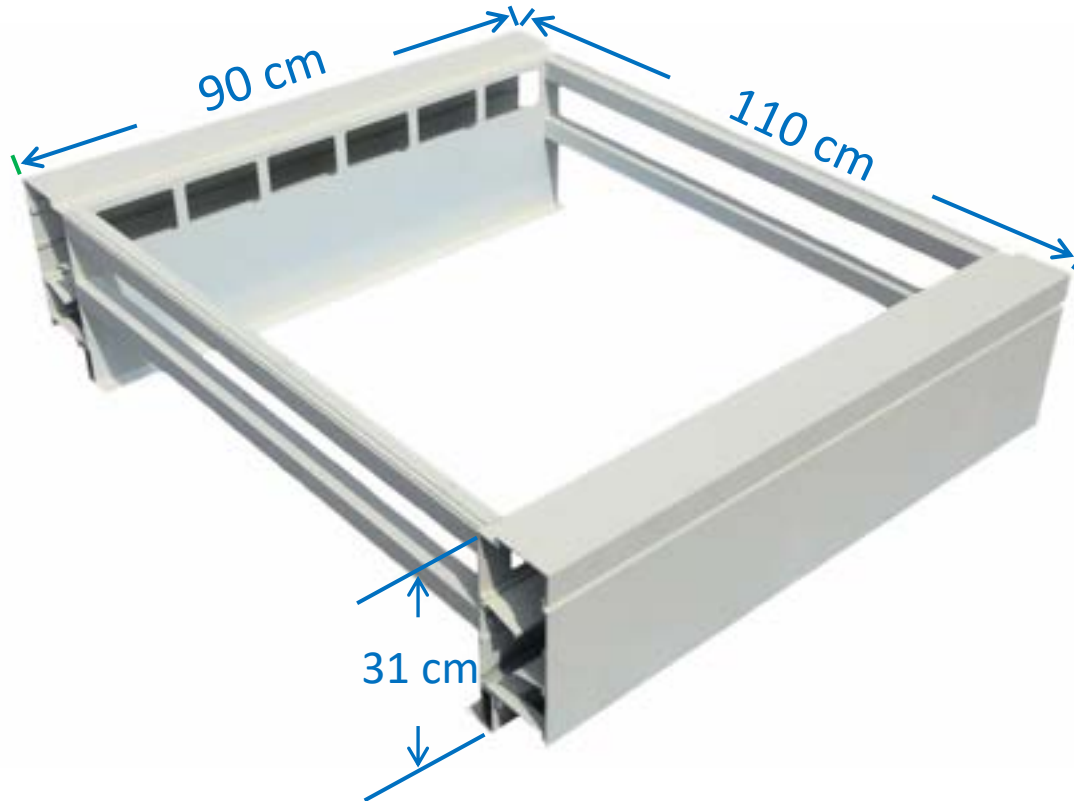

安裝流程:屋頂開洞

蓋浪板時預先留好開孔尺寸。C型鋼位置跟開孔尺寸請參考尺寸圖。



安裝流程:放置水切

將水切依溝頂尺寸切割並固定在C型鋼上



建議水切超過一溝溝頂



鎖點在溝頂上

安裝流程:天窗固定

依序將天窗放置在水切上，續接完後跟C型鋼做固定



安裝流程:放置玻璃

前後鎖上側封板(依現場溝槽形狀裁切)。

蓋上玻璃，施打矽利康(建議使用道康寧等級以上矽利康)。

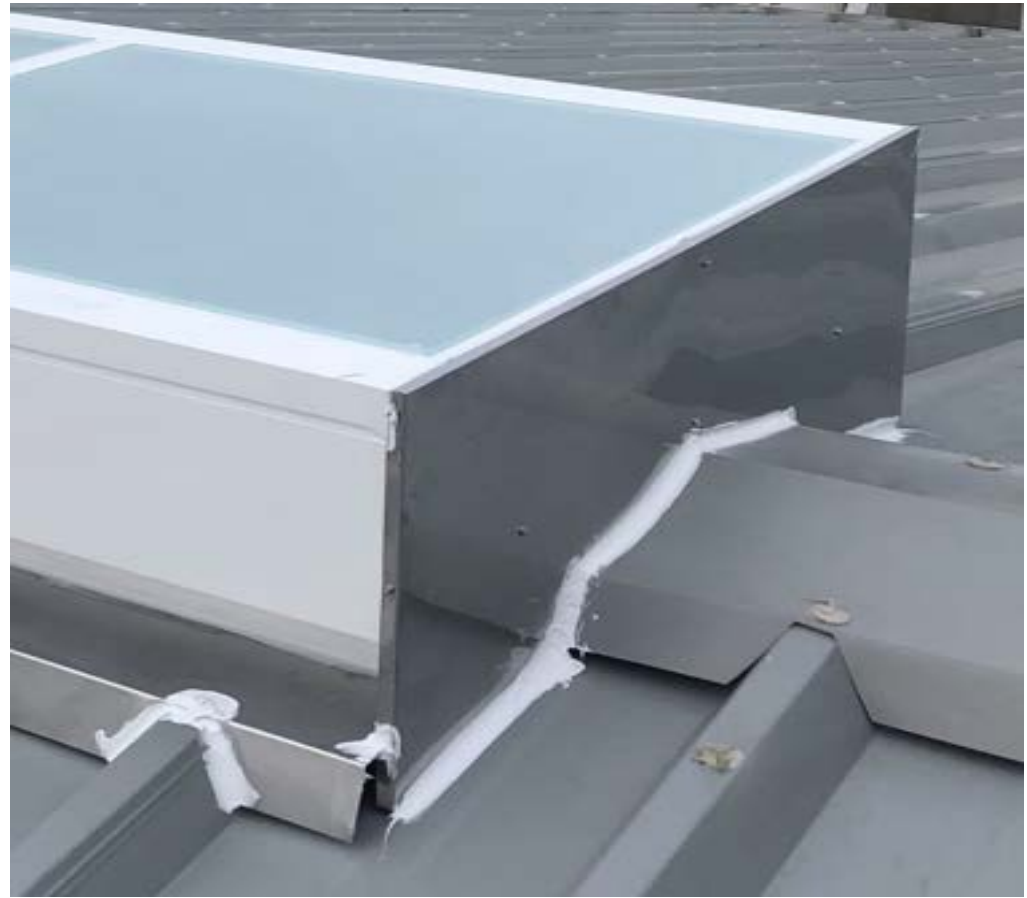

安裝流程:矽利康填縫

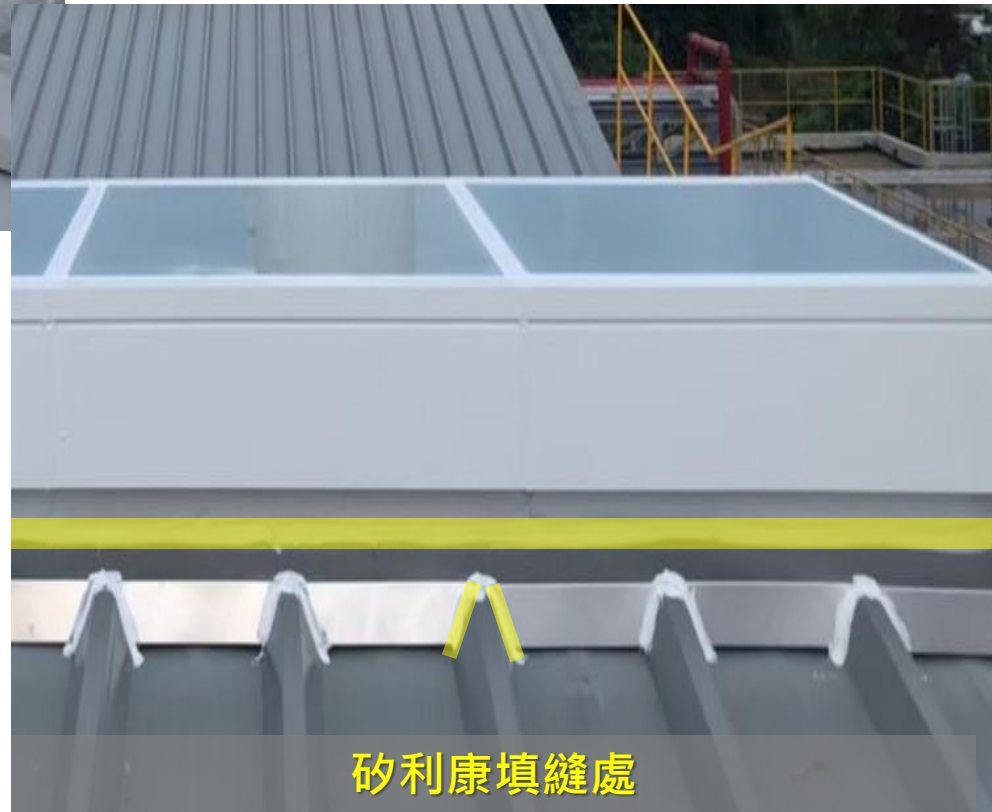

完成照

佛司特®

