

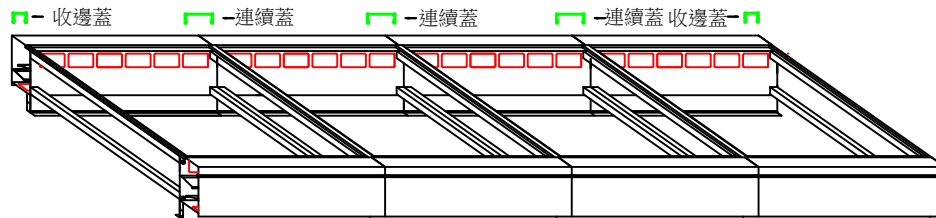

採光通風天窗-組裝圖

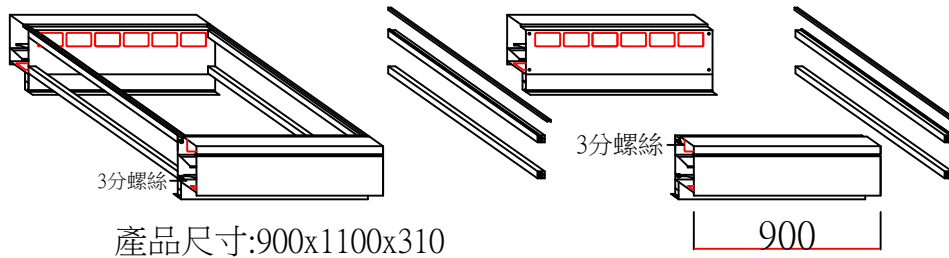
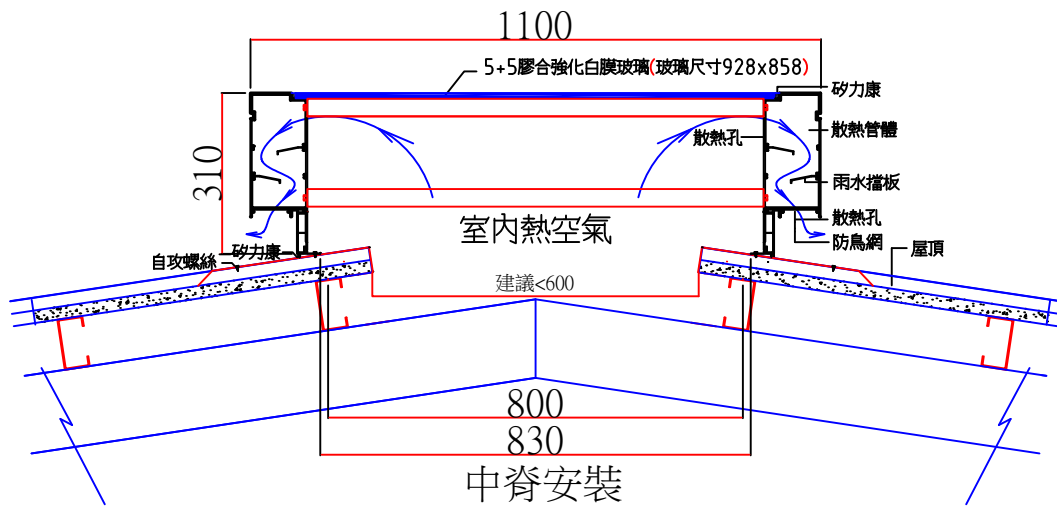
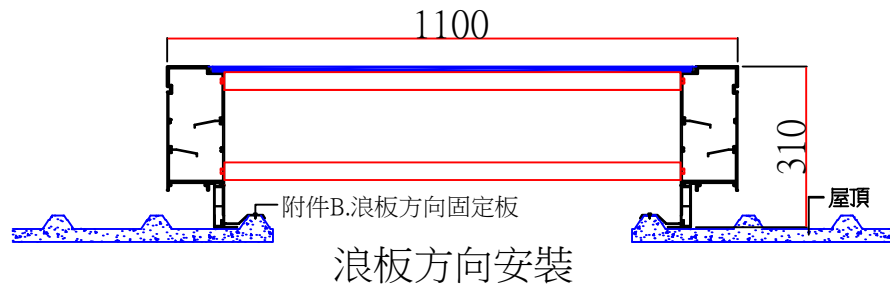
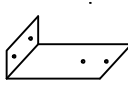

說明:	附件 A	附件 B	附件 C
1.本產品已專利在案.請勿仿冒 2.專利案號:新型第M470862號 3.專利案號:新型第M526600號 4.本產品採用鋁擠型材質. 5.本產品不含玻璃.側封板.固定片 6.附件請另行購買.	 材質:不銹鋼	 材質:鋁擠型	 材質:不銹鋼
	採光散熱窗側封板	浪板方向安裝.固定片	中脊加強用.固定片